



**JN**<sup>TM</sup>  
**JONEEL**  
■■■■ IMAGINATION CREATES INNOVATION

MATT  
SERIES

600X1200MM  
600X900MM  
600X600MM

OUTDOOR  
PORCELAIN  
TILES

# About US

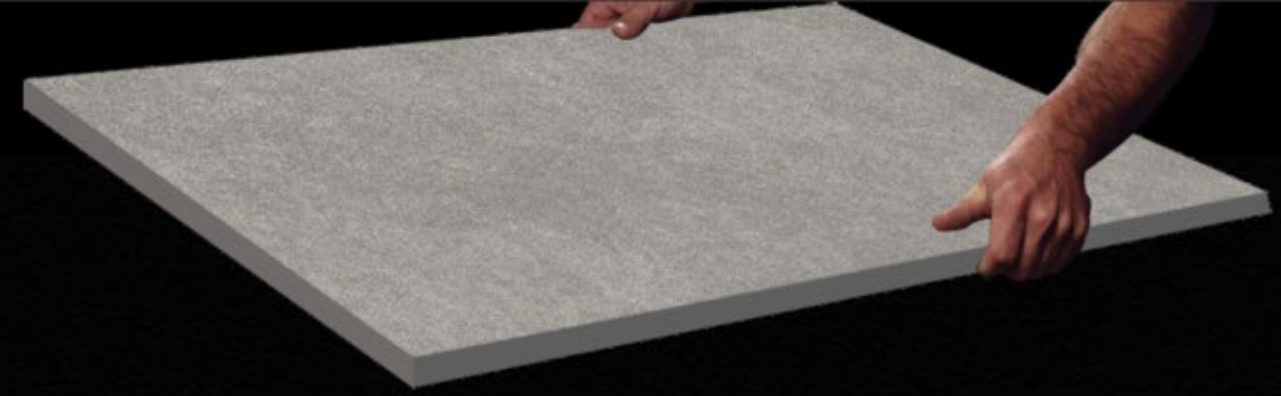

Our Group is one of the leading manufacturer & exporter of technically-advanced, Vitrified Tiles & Sanitary Ware, providing an extensive range of tile decor options for both residential and commercial interiors. We believe in values of - "innovation, Quality Products and Customer Satisfaction".  
Product Range : Vitrified Tiles & Sanitary Ware.

These offered range of tiles find applications in Residential & Commercial complexes, IT Parks, Hotels & Restaurants, Airports, Hospitals as well as other housing constructions and restoration of existing structures.

Backed with advanced & sophisticated state-of-the-art infrastructure facility, we are well-equipped with latest designing & manufacturing amenities. This also facilitates us in persistently improving every aspect of our operations. Further, we lay prime emphasis on the human factors occupied in our business.

let me  
introduce

you to the strong and  
gentle soul of stone

600x1200mm

600x900mm

Thickness  
16mm | 20mm

600x600mm

Size ( mm )	600x1200   600x900   600x600
Thickness ( mm )	16mm   20mm
Surface	MATT- R09   R11
Surface Punch	Plain   Stone   Slate
Color Body	Ivory   Grey  Black



Mountain Grey



Caspian Iron



Polar Brown



Caspian Pearl



Vintage Smoke

1

Bring Fabulous  
Design

2

Classic design

3

Shades of Petals  
Look

4

A Perfect Ideal  
Choice

## OUTDOOR PORCELAIN TILES

A versatile and high-performance porcelain stoneware, incorporating all the aesthetic qualities of natural stone, for spaces in which people are the focal point, surrounded by beautiful and eternal surfaces that combine wellbeing, beauty and practicality

The requirements of modern architecture are combined with the fascination with natural stone. Inspiration has been taken from Irish Stone, proposing new systems for a covering of great aesthetic value, destined to be a key feature.

# TILE LAYING POSSIBILITIES

16 | 20mm THICKNESS



LAYING ON SCREED  
WITH ADHESIVES



LAYING ON A  
RAISED FLOOR



LAYING ON  
GRAVEL

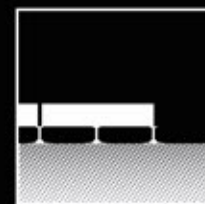

DRY LAYING ON  
THE GRASS



A reflection on the primitive and minimalist form of stone and on the different finishes that originate from the different ways of working this material: this is what inspired the Stonetalk collection.

The various that make up the collection capture all the splendor of real marble, highlighting one of the wonders offered by nature and provoking at the very first sight the same strong emotional impact experienced.



The dark stone stands out due to its decisive but refined mood and can also transmit these features to large architectural spaces.



# ROBUST THICKNESS MIGHTY DURABILITY

The substantial thickness of 20mm of the collection lends the surfaces exceptional durability and resilience. The thickness offers surfaces durability to endure heavy traffic, weight, and rugged use and makes the surfaces practically ideal for all kinds of usages. The thickness paired with R11 anti-skid surfaces makes the surfaces of the collection extremely safe for use outdoors.

20MM  
THICKNESS



## BENIFITS OF 20MM OUTDOOR TILES

Stress-Resistant			High Tensile Strength
Antislip (R11)			Weather Resistant
Easy To Clean Due To The Lack Of Adhesives And Filler			Easy To Install Even Without Adhesives Or Filler
Frost And Fire-resistant			Removable And Reusable
Good Drainage, Facilitates The Flow Of Water And Rainfall, Eliminating Harmful Stagnation			Ideal For Paving Outdoor Installations, Including Raised Paving.
Easily Inspected And Functional, Allows Installation And Maintenance Of Cabling And Pipework.			Highly Resistant To Changes In Temperature

The robustly crafted collection comes with a plethora of features and benefits and aids in an effortless and risk-free lifestyle with attributes like r11 anti-slip surfaces, resistance to heat, frost, fire, weather, stains, and more, and also very easy to maintain. On top of features, the surfaces are easy to install, removable, and reusable.

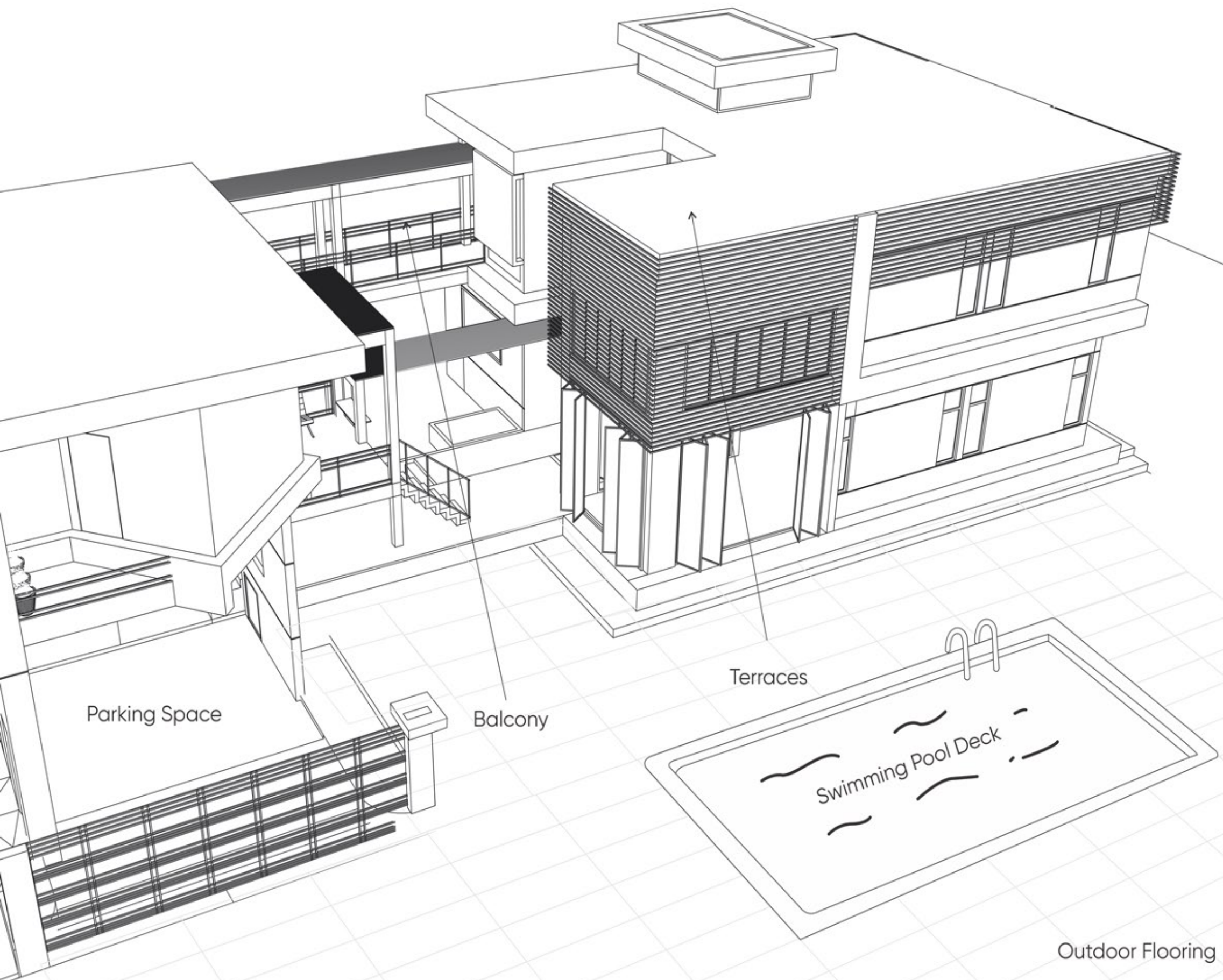

Terraces, pathways and covered pools clad with 20mm outdoor porcelain effortlessly merge with the surrounding spaces and nature. Internal flooring that seamlessly communicates and runs into external surfaces. With 20mm outdoor porcelain, urban areas like public parks, gardens and swimming pools unexpectedly become delightful scenic locations.

The products featured in this catalogue are primarily suggested for external spaces that require floorings with anti-skid properties.

Parking Lot

Outdoor Flooring

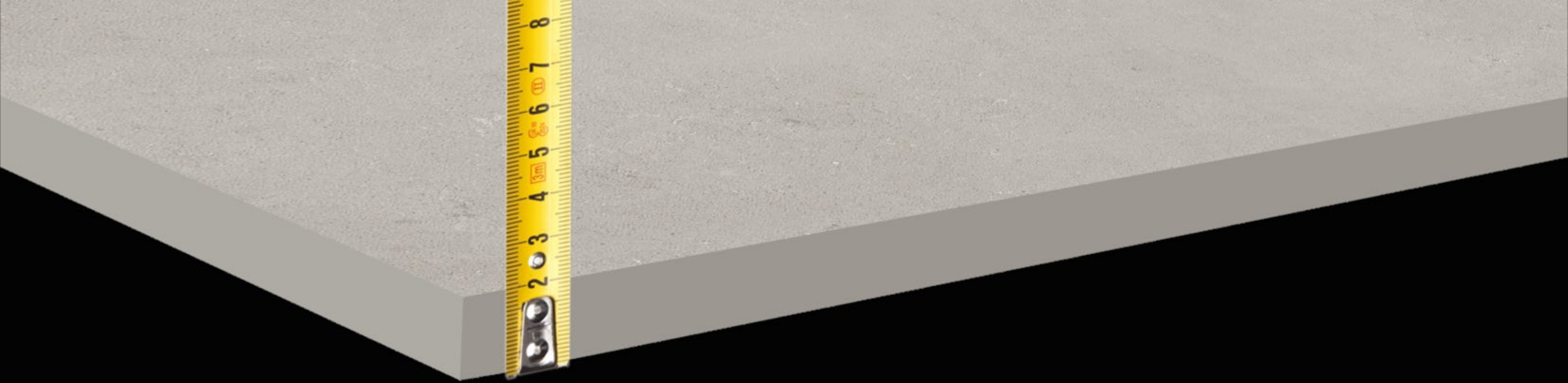

# Application Areas

Our 20 mm thick Outdoor Porcelain vitrified tile by Our brings together aesthetically appealing quality and the best technical performance and could be used over almost all external areas and usages without the risk of breakage. They are resistant to frost and also to sudden temperature changes besides being anti-slip, easy to clean and are designed to retain their texture and colour over their lifetime.



Public Parks,  
Gardens



Terraces and  
Balconies

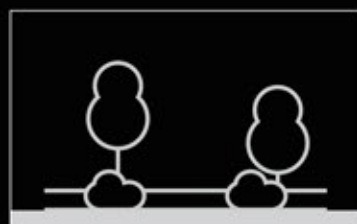

Driveways and  
Pathways



Swimming Pools and  
Surrounding Areas



Out door patio and  
verandah



Beach  
Resorts



Parking Lots and  
Vehical Passage



Street  
Furniture



High-traffic  
Industrial Areas



TERRACES

# Laying Patterns

**MAKE NATURAL LOOKING PATTERNS  
LIKE INTERLOCKING, RANDOM,  
REPETITIVE, SQUARES WITH  
OUR OUTDOOR PORCELAIN**

Tiles Combination & Cutting Tiles

**600x1200mm | 600x900mm | 600x600mm | 300x600mm | 300x300mm**



Please note that your stockist may offer the tiles in different pack sizes. All dimensions are standard and all products are designed to be laid with appropriate joints. Please refer to our step-by-step laying guide for additional information on this topic. Also, when using multiple tile packs, always mix the tiles before laying to achieve an overall blended appearance.

Tiles Combination

**600x1200mm**

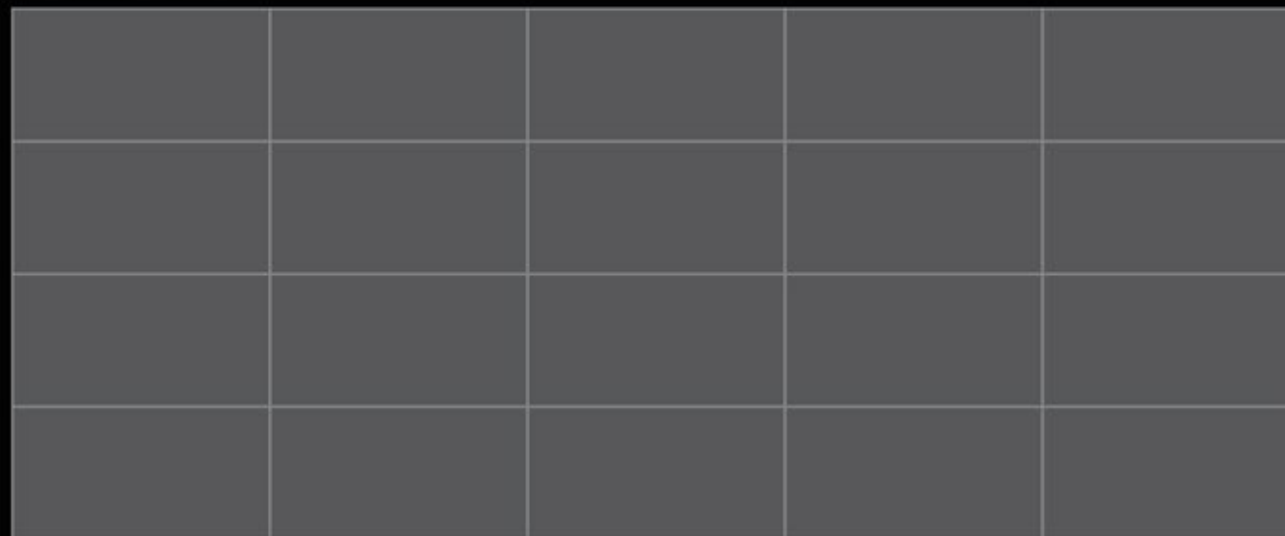

Tiles Combination

**600x900mm**



Tiles Combination & Cutting Tiles

**600x600mm**





# INDEX

■ ARABIAN.....10	■ ELBRUS.....32	■ MOUNTAIN GREY.....54	■ TIMBER WOOD.....76
■ BRAZILIAN BLACK.....12	■ ENRICH GREY.....34	■ MOUNTAIN IVORY.....56	■ VICTORIA.....78
■ BRAZILIAN GREY.....14	■ FOSSIL MINT.....36	■ PERLINO BEIGE.....58	■ VINTAGE ALMOND.....80
■ CASPIAN IRON.....16	■ KANDLA GREY.....38	■ PINE ALMOND.....60	■ VINTAGE SMOKE.....82
■ CASPIAN PEARL.....18	■ LI RIVER.....40	■ PINE OLIVE.....62	■ ZION BROWN.....84
■ CASPIAN WHITE.....20	■ MARVEL BIANCO.....42	■ POLAR BROWN.....64	■ METAL SMOKE .....86
■ COUNTRY ANTHRACITE.....22	■ MARVEL GREY.....44	■ POLAR CREMA.....66	■ OPEC BEIGE .....88
■ COUNTRY CREMA.....24	■ MARVEL NERO.....46	■ POLO BEIGE.....68	■ OPEC IVORY .....90
■ COUNTRY GRIS.....26	■ MATIRA SNOW.....48	■ RIVER BLUE.....70	
■ COUNTRY LGY.....28	■ MOUNT KOYA.....50	■ RIVER GRAPHITE.....72	
■ DEAD SEA.....30	■ MOUNTAIN BLACK.....52	■ RIVER GREY.....74	

# ARABIAN

## SURFACE

MATT- R09 | R11

## THICKNESS

16mm | 20mm

## SIZE

600x1200mm  
600x900mm  
600x600mm

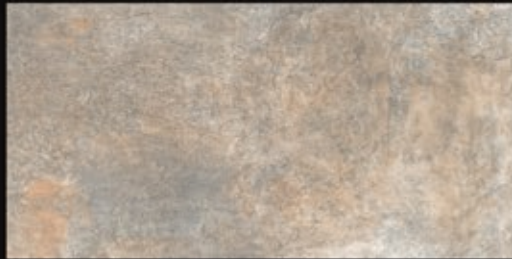

Plain Punch  
Slate Punch  
Stone Punch

Random- 4



## Experience

# The Luxury Perfection

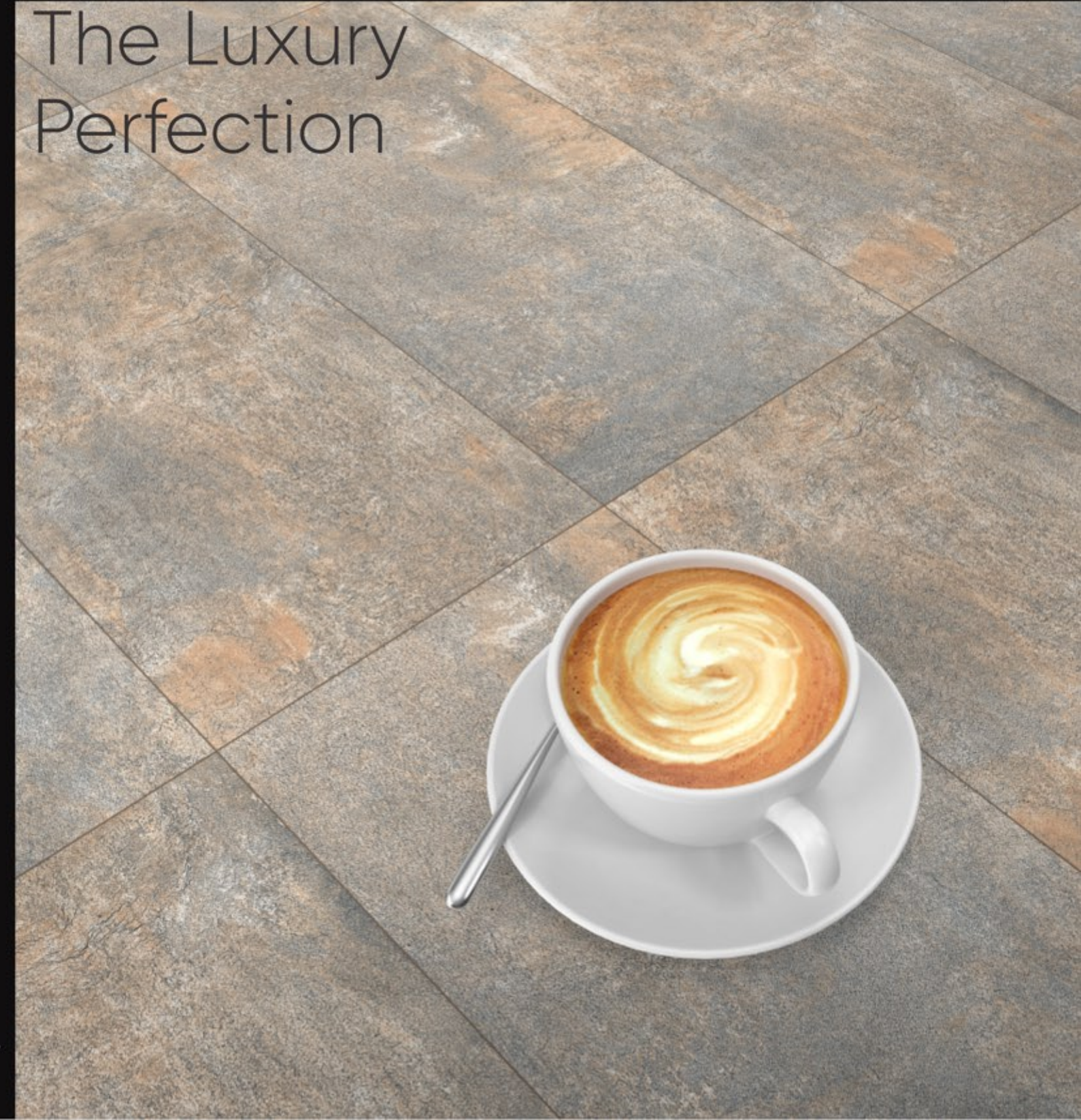



ARABIAN

# BRAZILIAN BLACK

## SURFACE

MATT- R09 | R11

## THICKNESS

16mm | 20mm

## SIZE

600x1200mm  
600x900mm  
600x600mm

Random- 9

Plain Punch  
Slate Punch  
Stone Punch

Make Your  
Space More  
Shining





**BRAZILIAN BLACK**

# BRAZILIAN GREY

## SURFACE

MATT- R09 | R11

## THICKNESS

16mm | 20mm

## SIZE

600x1200mm  
600x900mm  
600x600mm

Random- 9



Plain Punch  
Slate Punch  
Stone Punch

# Giving The Marvelous Touch





**BRAZILIAN GREY**

# CASPIAN IRON

## SURFACE

MATT- R09 | R11

## THICKNESS

16mm | 20mm

## SIZE

600x1200mm  
600x900mm  
600x600mm

Random- 9

Plain Punch  
Slate Punch  
Stone Punch

Bring Classic  
Beauty To Your  
Space







CASPIAN IRON

# CASPIAN PEARL

## SURFACE

MATT- R09 | R11

## THICKNESS

16mm | 20mm

## SIZE

600x1200mm  
600x900mm  
600x600mm

Random- 9

Plain Punch  
Slate Punch  
Stone Punch

## The Impact Of Graceful Ambiance





**CASPIAN PEARL**

# CASPIAN WHITE

## SURFACE

MATT- R09 | R11

## THICKNESS

16mm | 20mm

## SIZE

600x1200mm

600x900mm

600x600mm

Random- 9

Plain Punch  
Slate Punch  
Stone Punch

## Unmatched

## Brilliance Of Style





CASPIAN WHITE

# COUNTRY ANTHRACITE

**SURFACE**  
MATT- R09 | R11

**THICKNESS**  
16mm | 20mm

**SIZE**  
600x1200mm  
600x900mm  
600x600mm

Plain Punch  
Slate Punch  
Stone Punch

Random- 7

Create A  
Balanced And  
Subtle  
Atmosphere





**COUNTRY ANTHRACITE**

# COUNTRY CREMA

**SURFACE**  
MATT- R09 | R11

**THICKNESS**  
16mm | 20mm

**SIZE**  
600x1200mm  
600x900mm  
600x600mm

Random- 7

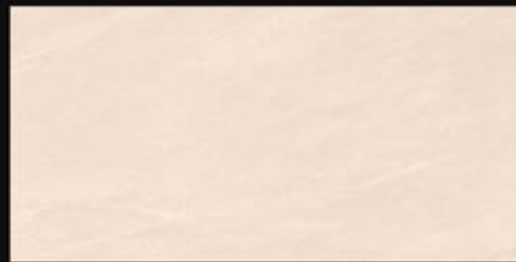

Plain Punch  
Slate Punch  
Stone Punch

Creates  
Balanced And  
Minimal Spaces







COUNTRY CREMA

# COUNTRY GRIS

## SURFACE

MATT- R09 | R11

## THICKNESS

16mm | 20mm

## SIZE

600x1200mm  
600x900mm  
600x600mm

Random- 7

Plain Punch  
Slate Punch  
Stone Punch

# Aesthetic Charm To The Space





**COUNTRY GRIS**

# COUNTRY LGY

## SURFACE

MATT- R09 | R11

## THICKNESS

16mm | 20mm

## SIZE

600x1200mm  
600x900mm  
600x600mm

Random- 7



Plain Punch  
Slate Punch  
Stone Punch



Give Your  
Space A  
Stunning Look





**COUNTRY LGY**

# DEAD SEA

**SURFACE**  
MATT- R09 | R11

**THICKNESS**  
16mm | 20mm

**SIZE**  
600x1200mm  
600x900mm  
600x600mm

Random- 4



Plain Punch  
Slate Punch  
Stone Punch



Bring In The  
Trendy Designs  
You Need

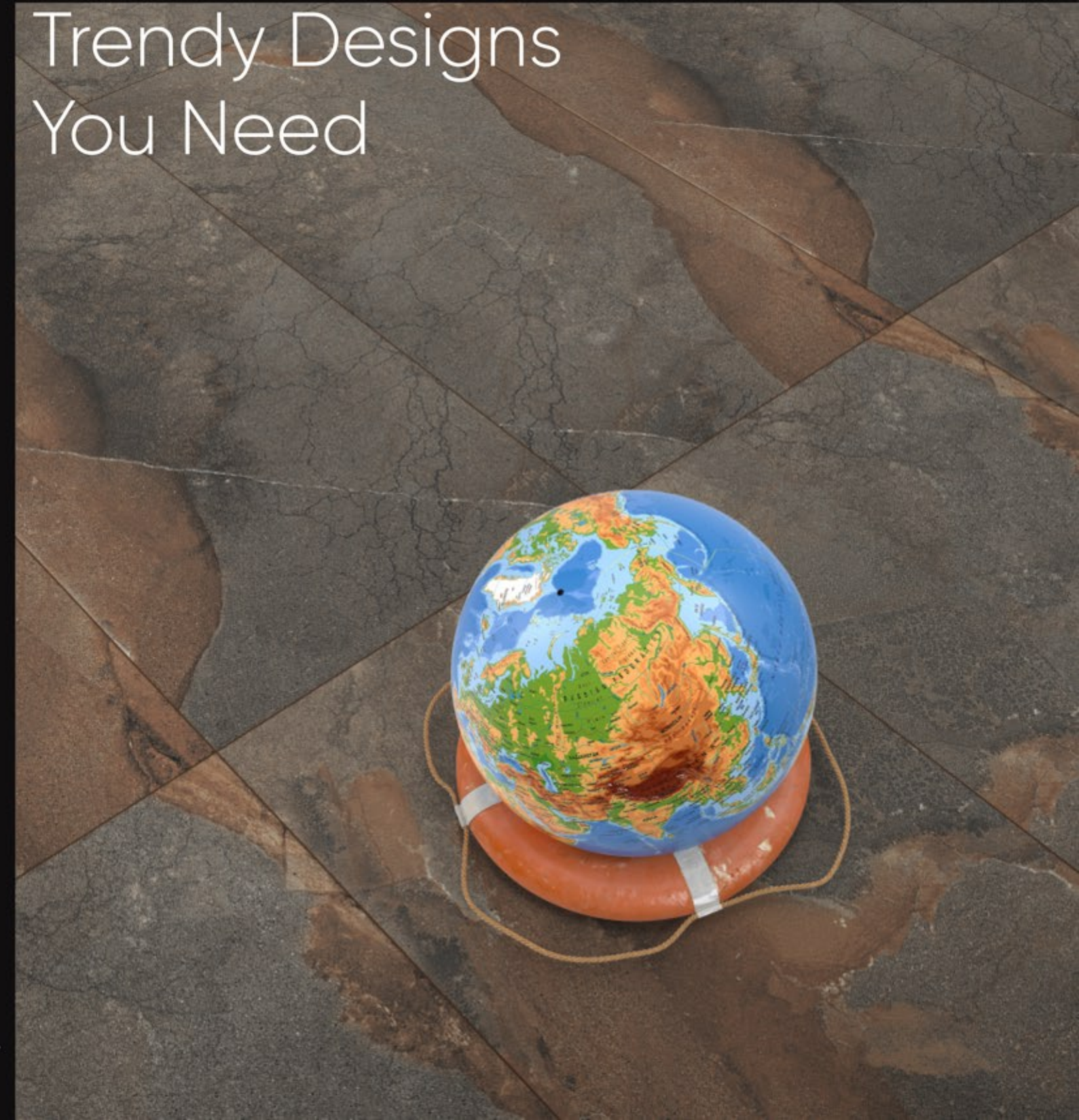



DEAD SEA

# ELBRUS

## SURFACE

MATT- R09 | R11

## THICKNESS

16mm | 20mm

## SIZE

600x1200mm  
600x900mm  
600x600mm



Plain Punch  
Slate Punch  
Stone Punch

Random- 4



# Enhance The Environment Of Your Space







**ELBRUS**

# ENRICH GREY

## SURFACE

MATT- R09 | R11

## THICKNESS

16mm | 20mm

## SIZE

600x1200mm  
600x900mm  
600x600mm



Plain Punch  
Slate Punch  
Stone Punch



Random- 4



Elegance To  
Enhance Your  
Ambience





**ENRICH GREY**

# FOSSIL MINT

## SURFACE

MATT- R09 | R11

## THICKNESS

16mm | 20mm

## SIZE

600x1200mm  
600x900mm  
600x600mm

Random- 8



Plain Punch  
Slate Punch  
Stone Punch

# Explore Our New Collection





**FOSSIL MINT**

# KANDLA GREY

**SURFACE**  
MATT- R09 | R11

**THICKNESS**  
16mm | 20mm

**SIZE**  
600x1200mm  
600x900mm  
600x600mm

Random- 7



Plain Punch  
Slate Punch  
Stone Punch

Precious  
And Prosperity  
Look





**KANDLA GREY**

# LI RIVER

**SURFACE**  
MATT- R09 | R11

**THICKNESS**  
16mm | 20mm

**SIZE**  
600x1200mm  
600x900mm  
600x600mm



Plain Punch  
Slate Punch  
Stone Punch

Random- 4

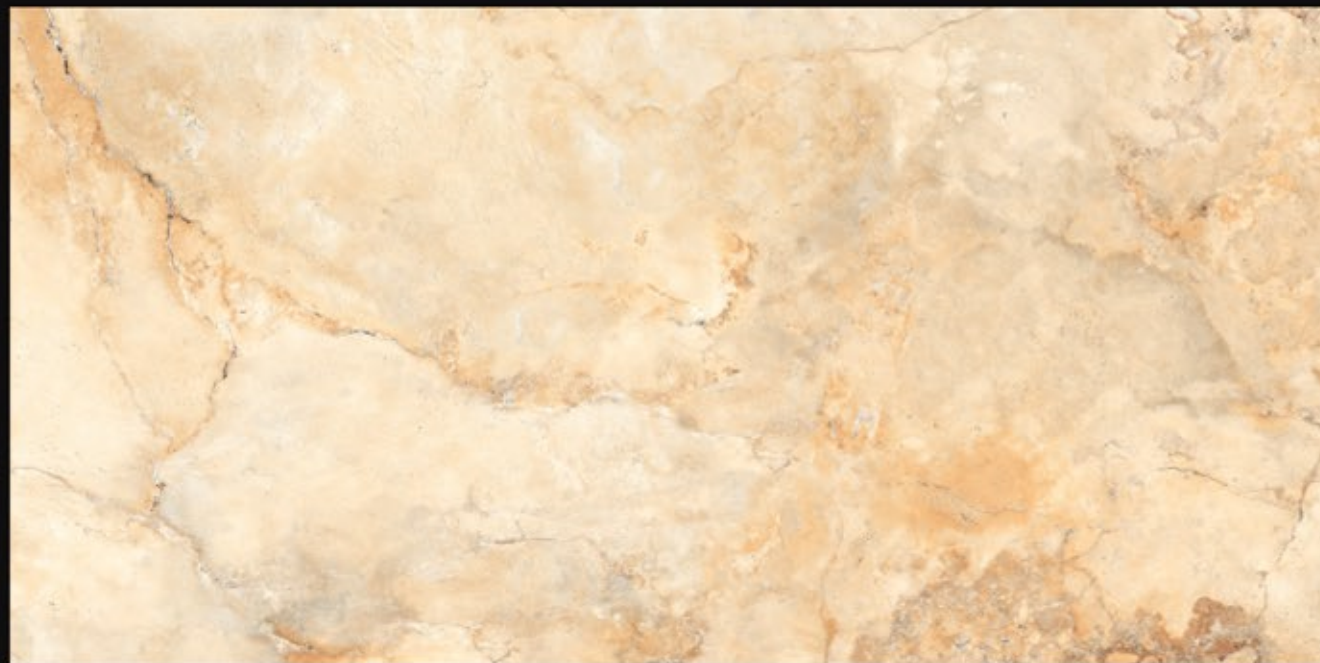

Make Your  
Place, As  
Your Dream

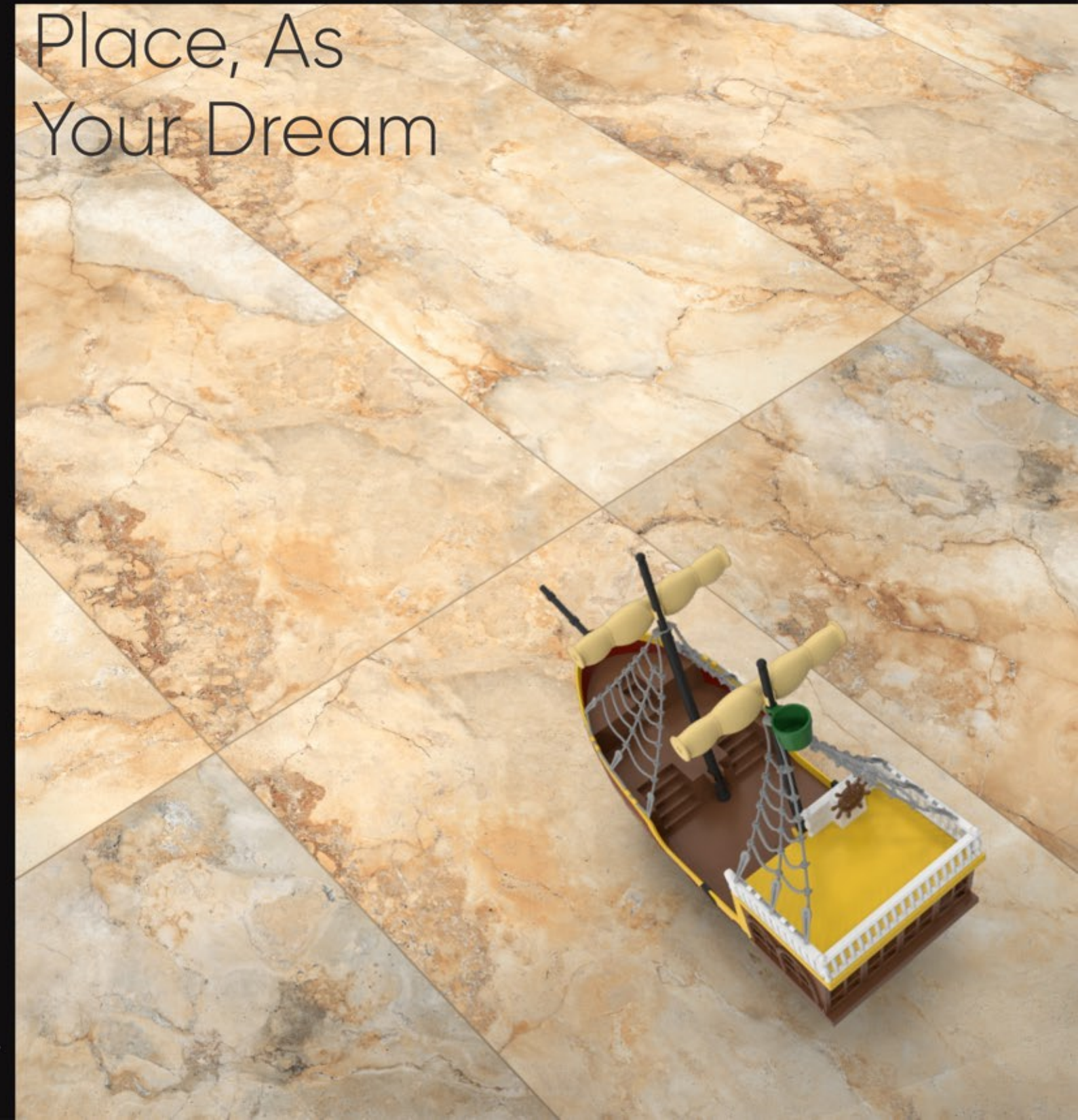





**LI RIVER**

# MARVEL BIANCO

## SURFACE

MATT- R09 | R11

## THICKNESS

16mm | 20mm

## SIZE

600x1200mm  
600x900mm  
600x600mm



Plain Punch  
Slate Punch  
Stone Punch

Random- 4



# Achieve Brilliant And Luxurious Spaces

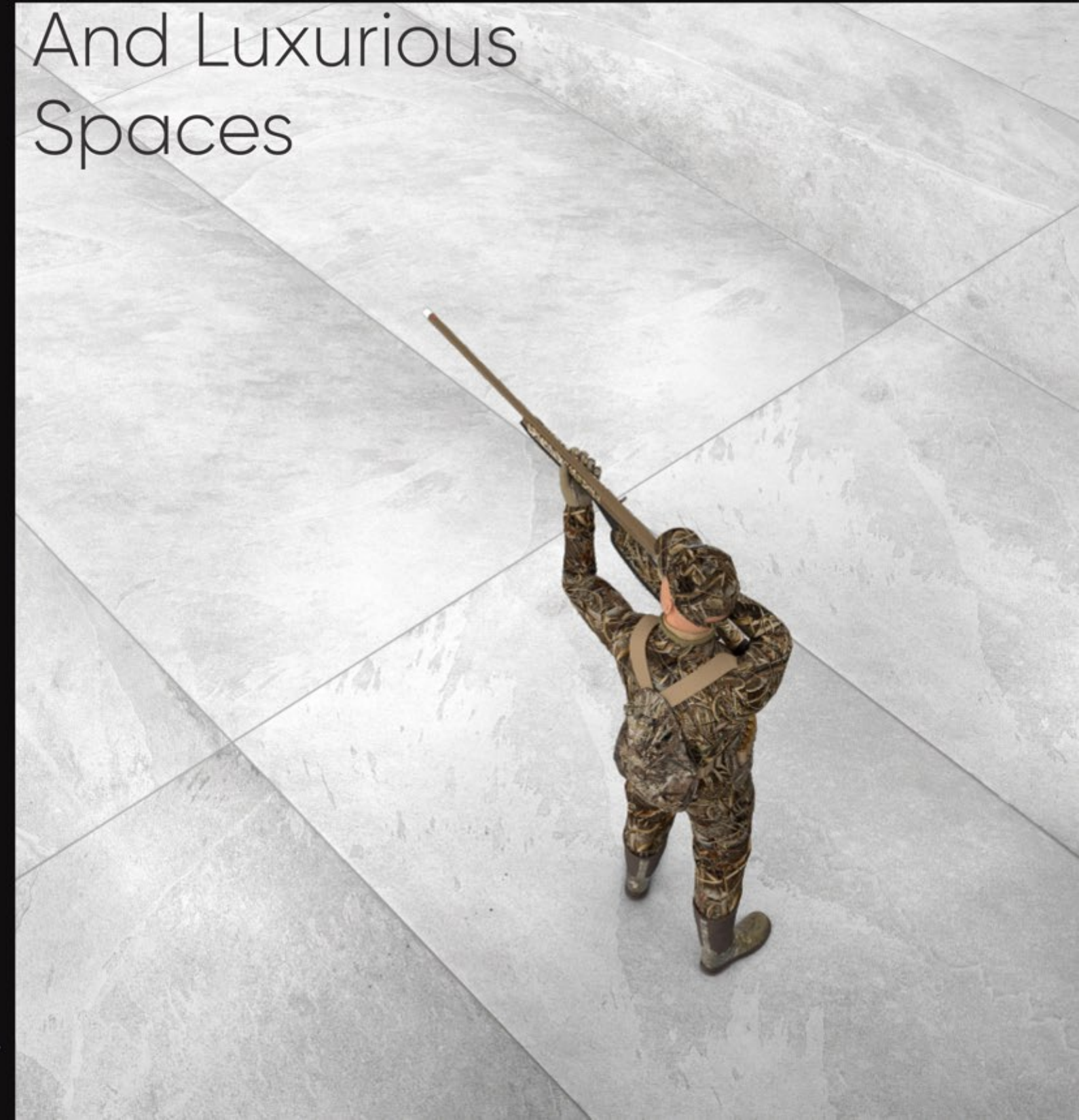



**MARVEL BIANCO**

# MARVEL GREY

## SURFACE

MATT- R09 | R11

## THICKNESS

16mm | 20mm

## SIZE

600x1200mm  
600x900mm  
600x600mm



Plain Punch  
Slate Punch  
Stone Punch

Random- 4



# Extraordinary

# Design For Your Spaces

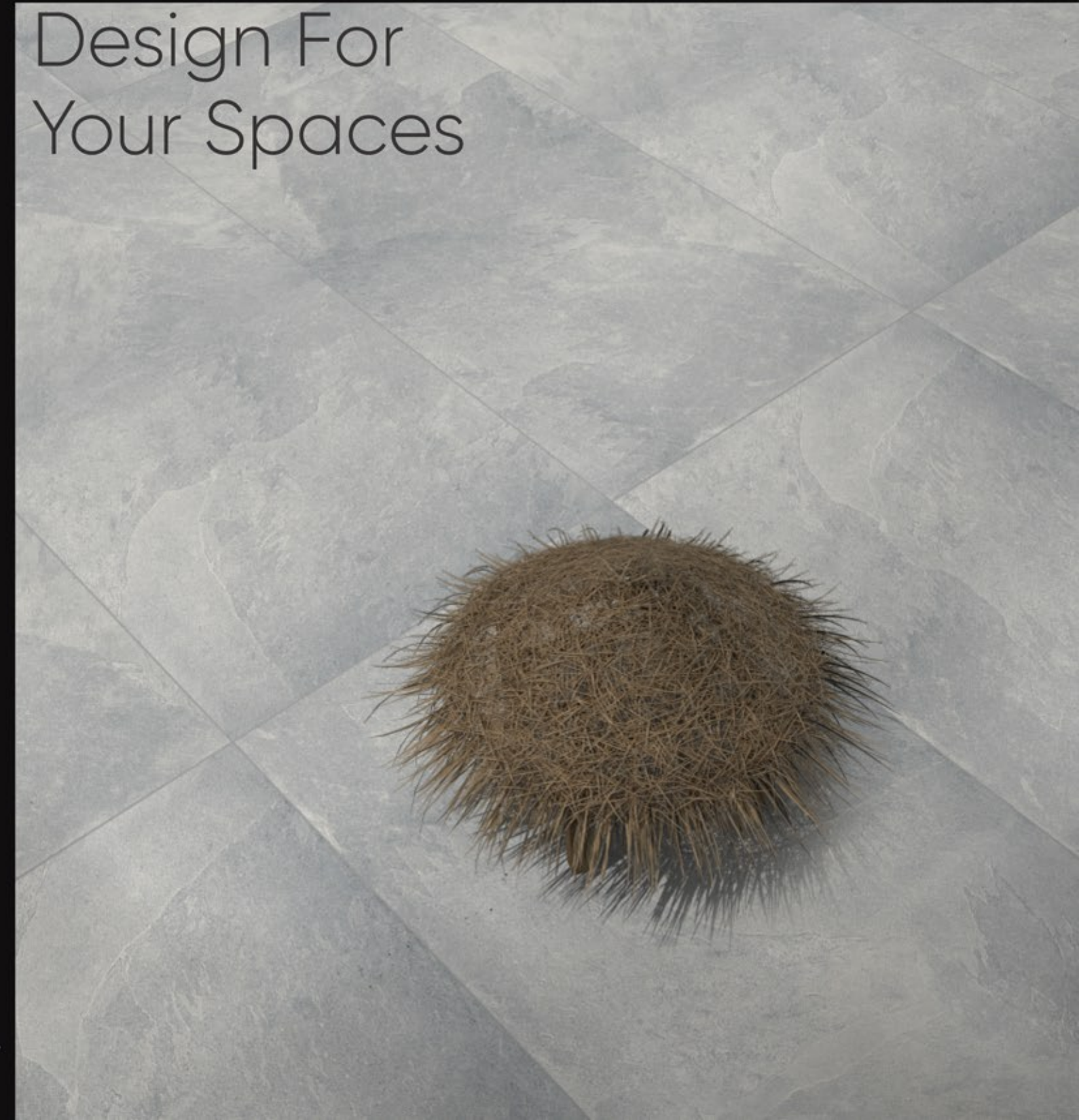



**MARVEL GREY**

# MARVEL NERO

**SURFACE**  
MATT- R09 | R11

**THICKNESS**  
16mm | 20mm

**SIZE**  
600x1200mm  
600x900mm  
600x600mm



Plain Punch  
Slate Punch  
Stone Punch

Random- 4



## Accentuate The Accents In Your Living Spaces





**MARVEL NERO**

# MATIRA SNOW

## SURFACE

MATT- R09 | R11

## THICKNESS

16mm | 20mm

## SIZE

600x1200mm  
600x900mm  
600x600mm



Plain Punch  
Slate Punch  
Stone Punch

Random- 4



Carve Your  
Dream Into  
Reality







**MATIRA SNOW**

# MOUNT KOYA

**SURFACE**  
MATT- R09 | R11

**THICKNESS**  
16mm | 20mm

**SIZE**  
600x1200mm  
600x900mm  
600x600mm

Random- 4



Plain Punch  
Slate Punch  
Stone Punch



Shades Give  
A Sense Of  
Unity





**MOUNT KOYA**

# MOUNTAIN BLACK

## SURFACE

MATT- R09 | R11

## THICKNESS

16mm | 20mm

## SIZE

600x1200mm  
600x900mm  
600x600mm

Plain Punch  
Slate Punch  
Stone Punch

Random- 3

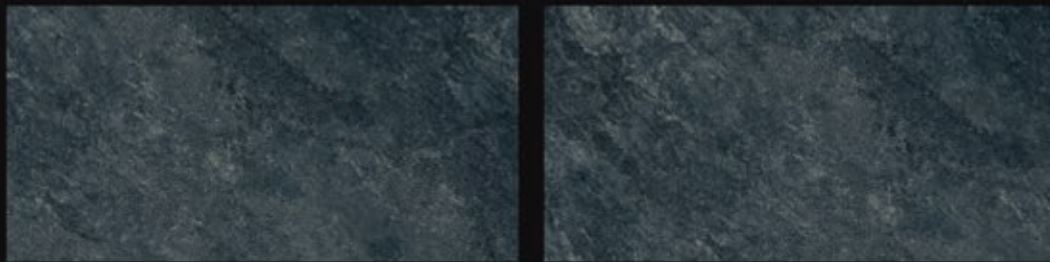

Design Your  
Spaces Creative  
And Mesmeric

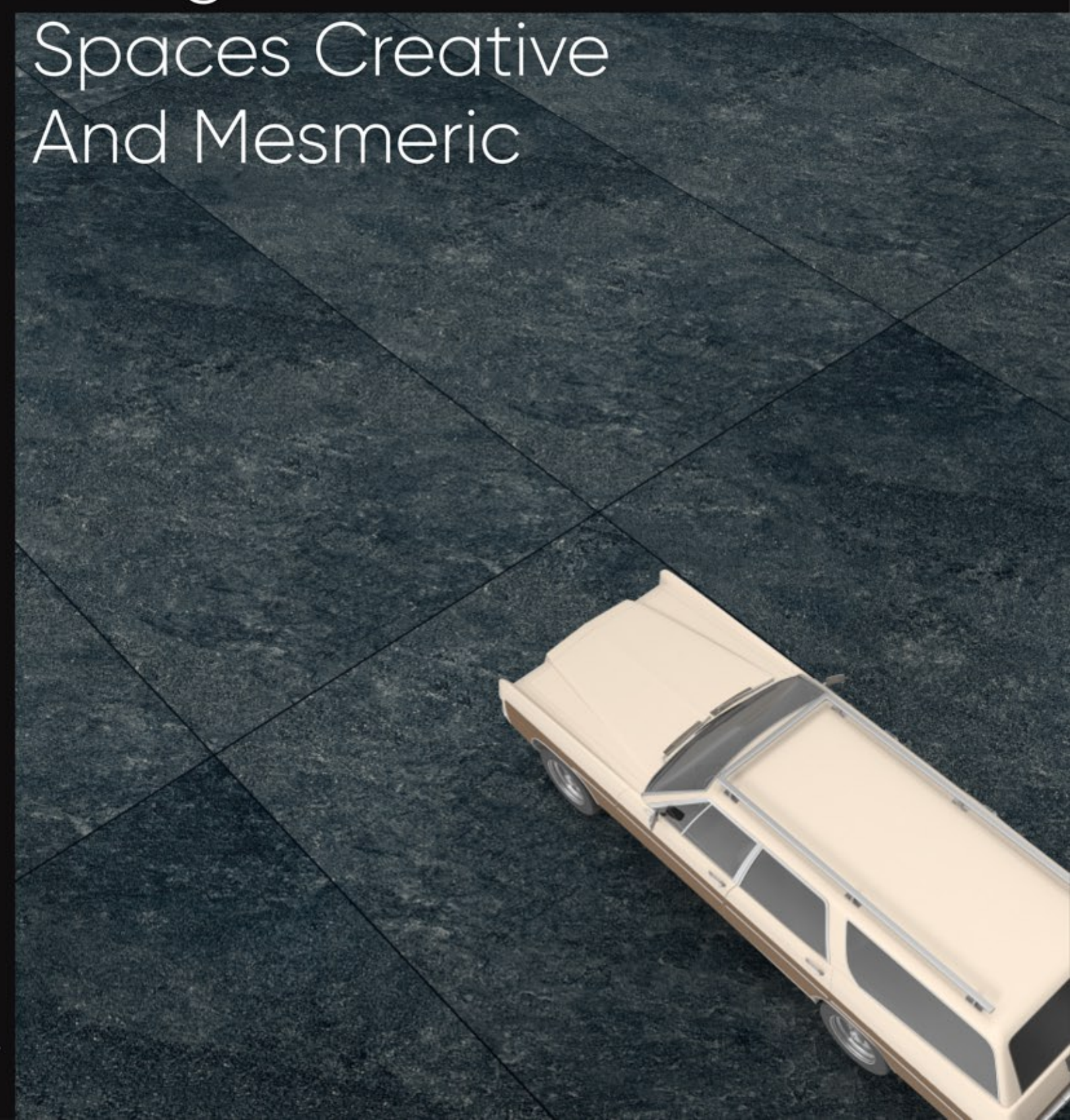



**MOUNTAIN BLACK**

# MOUNTAIN GREY

## SURFACE

MATT- R09 | R11

## THICKNESS

16mm | 20mm

## SIZE

600x1200mm  
600x900mm  
600x600mm

Plain Punch  
Slate Punch  
Stone Punch

Random- 3



# Transform Your Spaces Decorative And Ornate





**MOUNTAIN GREY**

# MOUNTAIN IVORY

## SURFACE

MATT- R09 | R11

## THICKNESS

16mm | 20mm

## SIZE

600x1200mm  
600x900mm  
600x600mm

Plain Punch  
Slate Punch  
Stone Punch

Random- 3

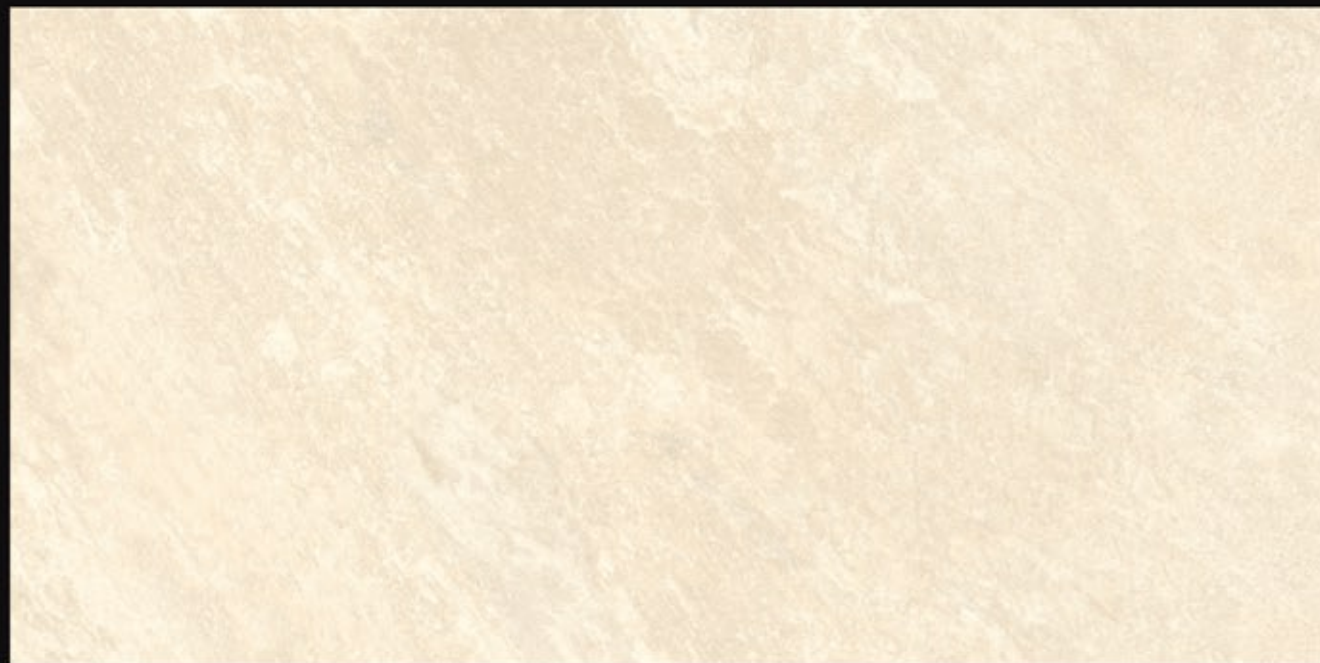

# Achieve Brilliant And Luxurious Spaces







**MOUNTAIN IVORY**

# PERLINO BEIGE

## SURFACE

MATT- R09 | R11

## THICKNESS

16mm | 20mm

## SIZE

600x1200mm  
600x900mm  
600x600mm

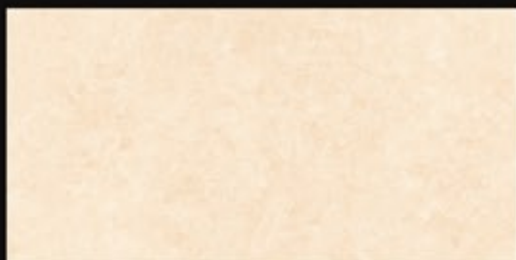

Plain Punch  
Slate Punch  
Stone Punch

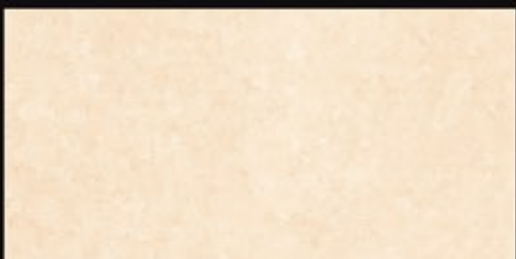
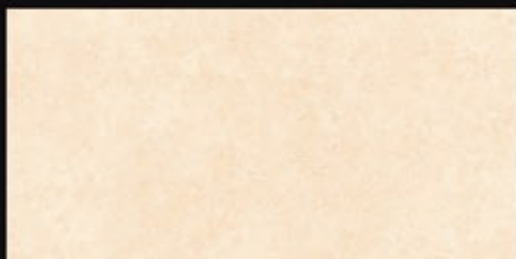

Random- 4

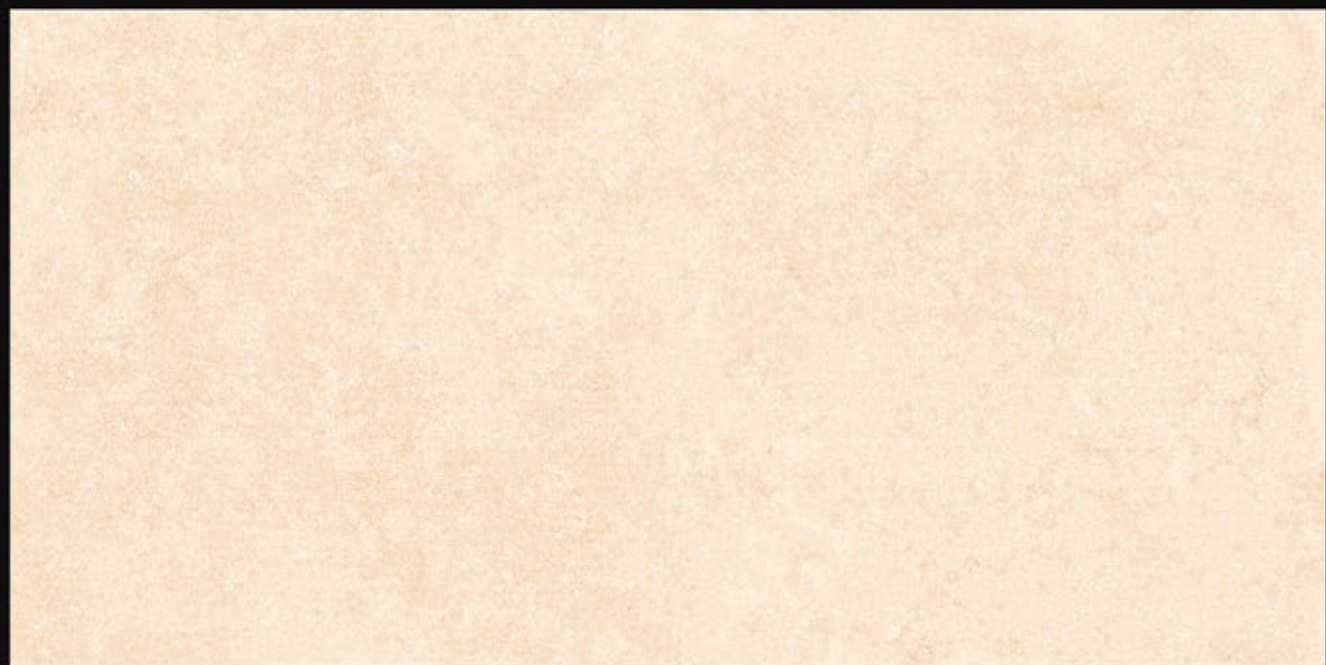

Elegance  
To Your  
Ambiance





**PERLINO BEIGE**

# PINE ALMOND

## SURFACE

MATT- R09 | R11

## THICKNESS

16mm | 20mm

## SIZE

600x1200mm  
600x900mm  
600x600mm

Plain Punch  
Slate Punch  
Stone Punch

Random- 4



# Mediterranean Calm To Your Spaces





**PINE ALMOND**

# PINE OLIVE

## SURFACE

MATT- R09 | R11

## THICKNESS

16mm | 20mm

## SIZE

600x1200mm  
600x900mm  
600x600mm



Plain Punch  
Slate Punch  
Stone Punch

Random- 4



Adds  
Character To  
Your Spaces





PINE OLIVE

# POLAR BROWN

## SURFACE

MATT- R09 | R11

## THICKNESS

16mm | 20mm

## SIZE

600x1200mm  
600x900mm  
600x600mm

Random- 4

Plain Punch  
Slate Punch  
Stone Punch

## Quirky Charm To Your Spaces







**POLAR BROWN**

# POLAR CREMA

## SURFACE

MATT- R09 | R11

## THICKNESS

16mm | 20mm

## SIZE

600x1200mm  
600x900mm  
600x600mm

Plain Punch  
Slate Punch  
Stone Punch

Random- 3



Enjoy The  
Beauty Of  
Symmetry





**POLAR CREMA**

# POLO BEIGE

## SURFACE

MATT- R09 | R11

## THICKNESS

16mm | 20mm

## SIZE

600x1200mm  
600x900mm  
600x600mm

Plain Punch  
Slate Punch  
Stone Punch

Random- 3



Unstoppable  
Trending For  
Your Choice





**POLO BEIGE**

# RIVER BLUE

## SURFACE

MATT- R09 | R11

## THICKNESS

16mm | 20mm

## SIZE

600x1200mm  
600x900mm  
600x600mm

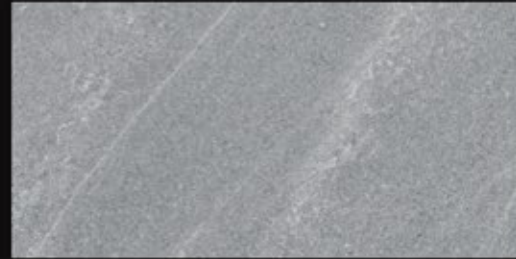

Plain Punch  
Slate Punch  
Stone Punch

Random- 4



# Sweet Home

# Made By Stunning Design





**RIVER BLUE**

# RIVER GRAPHITE

## SURFACE

MATT- R09 | R11

## THICKNESS

16mm | 20mm

## SIZE

600x1200mm  
600x900mm  
600x600mm



Plain Punch  
Slate Punch  
Stone Punch

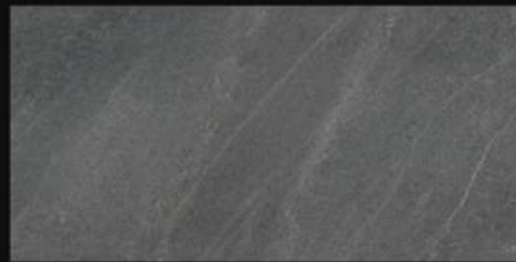
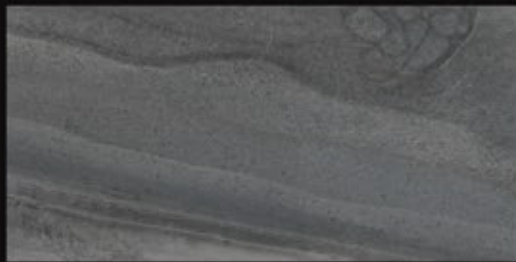

Random- 4



Create Your  
Imagination  
And Beyond  
The Limitless







**RIVER GRAPHITE**

# RIVER GREY

## SURFACE

MATT- R09 | R11

## THICKNESS

16mm | 20mm

## SIZE

600x1200mm  
600x900mm  
600x600mm



Plain Punch  
Slate Punch  
Stone Punch

Random- 4



Traditional Design  
Is Better Than  
Modern Design





RIVER GREY

# TIMBER WOOD

## SURFACE

MATT- R09 | R11

## THICKNESS

16mm | 20mm

## SIZE

600x1200mm  
600x900mm  
600x600mm



Plain Punch  
Slate Punch  
Stone Punch

Random- 4



# The Natural Artistry Of Each Unique Design





TIMBER WOOD

# VICTORIA

## SURFACE

MATT- R09 | R11

## THICKNESS

16mm | 20mm

## SIZE

600x1200mm  
600x900mm  
600x600mm

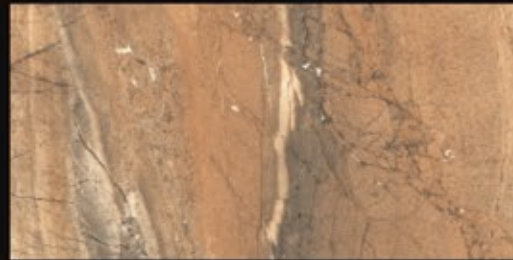

Plain Punch  
Slate Punch  
Stone Punch

Random- 4



## Inspiration

### Collection For Your Home





VICTORIA

# VINTAGE ALMOND

## SURFACE

MATT- R09 | R11

## THICKNESS

16mm | 20mm

## SIZE

600x1200mm  
600x900mm  
600x600mm



Plain Punch  
Slate Punch  
Stone Punch

Random- 3



Design Gives  
You The Vibes  
Of Happiness

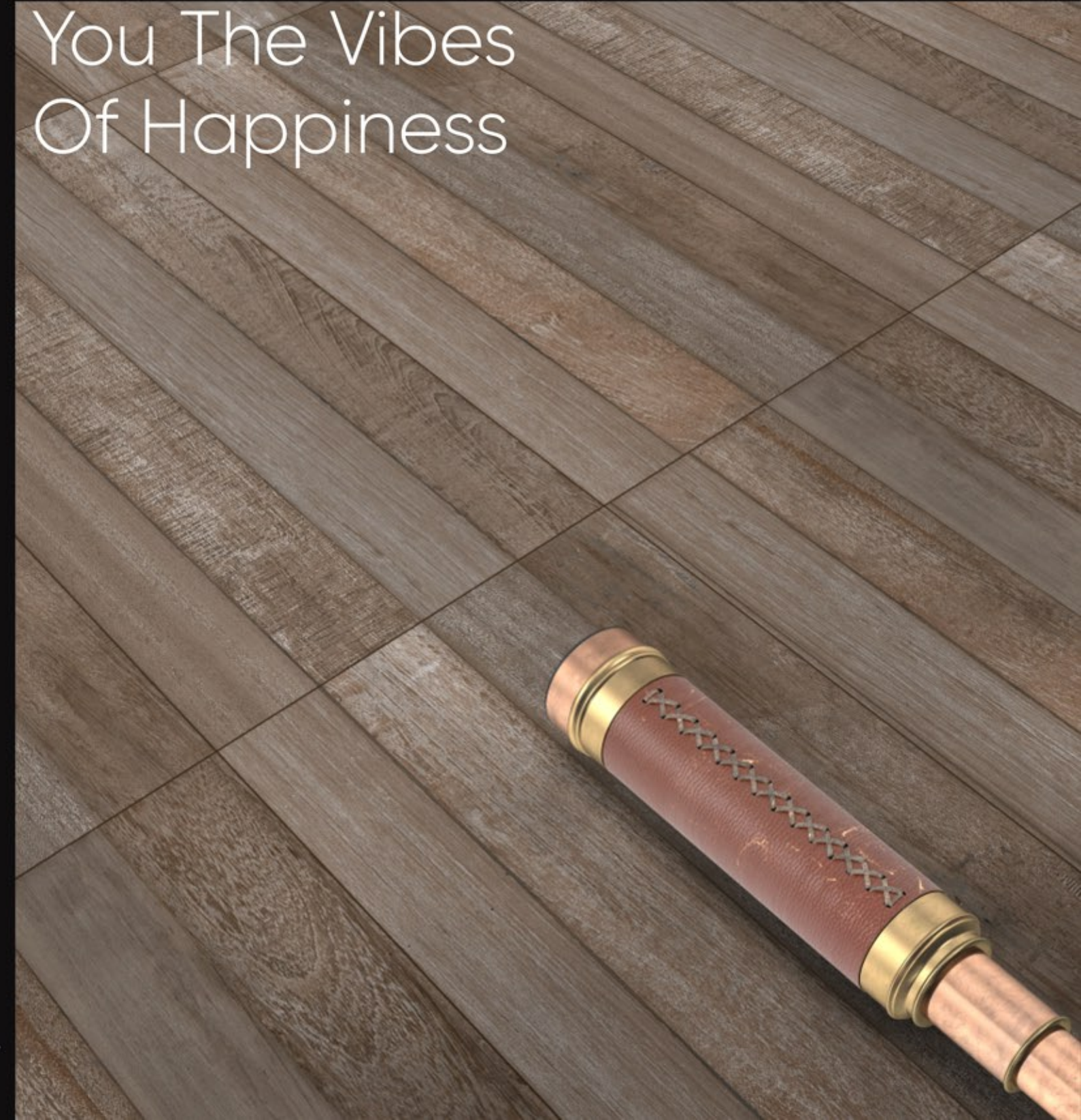





**VINTAGE ALMOND**

# VINTAGE SMOKE

## SURFACE

MATT- R09 | R11

## THICKNESS

16mm | 20mm

## SIZE

600x1200mm  
600x900mm  
600x600mm

Plain Punch  
Slate Punch  
Stone Punch

Random- 3



Feel Your  
Home Adorable  
At Every Time





VINTAGE SMOKE

# ZION BROWN

## SURFACE

MATT- R09 | R11

## THICKNESS

16mm | 20mm

## SIZE

600x1200mm  
600x900mm  
600x600mm



Plain Punch  
Slate Punch  
Stone Punch

Random- 4



Show Your  
Attitude At  
Every Move





ZION BROWN

# METAL SMOKE

## SURFACE

MATT- R09 | R11

## THICKNESS

16mm | 20mm

## SIZE

600x600mm

Random- 10

Plain Punch  
Slate Punch  
Stone Punch



## To Be

Perfect , To  
Be Wonderful





**METAL SMOKE**

# OPEC BEIGE

## SURFACE

MATT- R09 | R11

## THICKNESS

16mm | 20mm

## SIZE

600x600mm

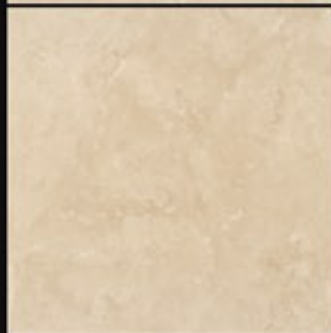

Plain Punch  
Slate Punch  
Stone Punch

Random- 6



## Always Ready

## For The Best Movement







**OPEC BEIGE**

# OPEC IVORY

## SURFACE

MATT- R09 | R11

## THICKNESS

16mm | 20mm

## SIZE

600x600mm

Random- 6

Plain Punch  
Slate Punch  
Stone Punch

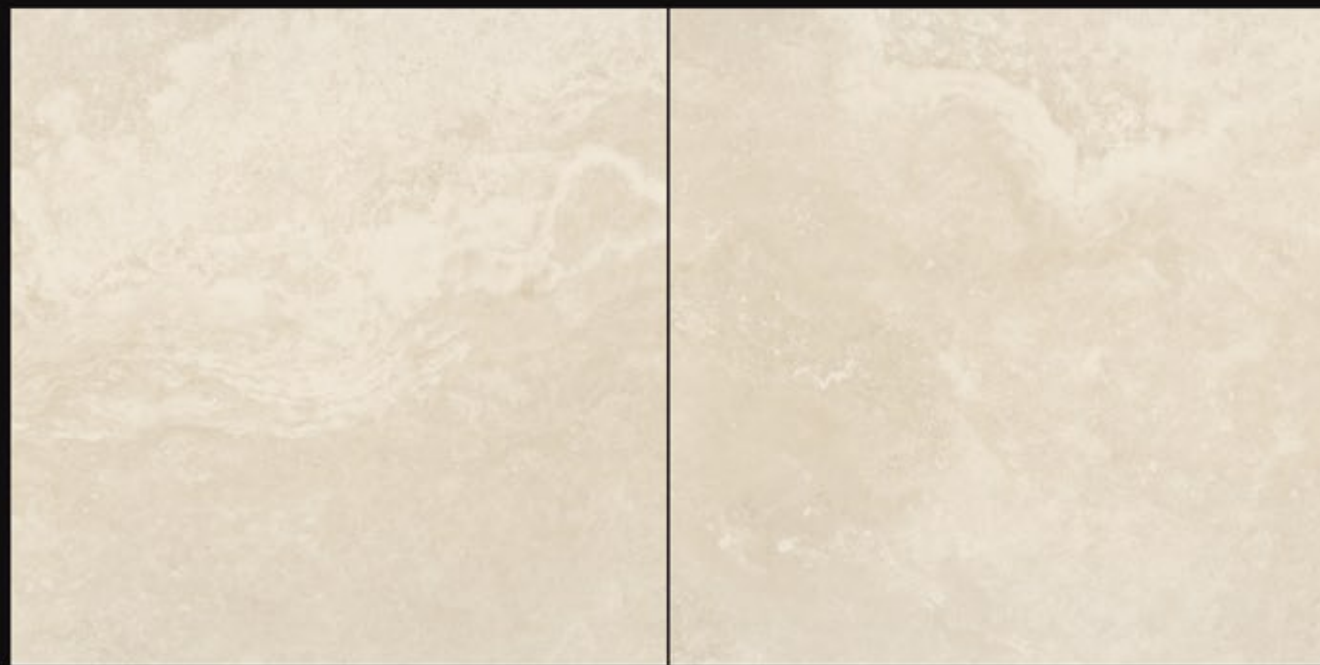

## Every Space

## Deserve Attention





**OPEC IVORY**

OUTDOOR  
PORCELAIN TILES

**PORCELAIN STONEWARE TILE 20MM FOR OUTDOOR FLOORING**

20mm outdoor porcelain stoneware is the product with the highest technical performance, ideal for flooring in an outdoor environment without the risk of breakage and without interrupting the continuity between interior and exterior spaces. Resistant to frost and thermal

shock, it has intensified anti-slip characteristics and is easy to clean. The perfect union between high technical performance and aesthetics helps maintain the material and color unchanged over time, guaranteeing long-lasting durability.

**VERSATILE**



Easy To Lay,  
Remove And Reuse



Colors Remain  
Stable Over Time

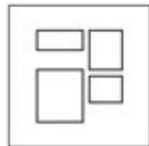

Outdoor And  
Indoor Flooring



Attention To Detail



Can Be Installed With Different  
Laying Systems

**RESISTANT**



Frost-Resistant



Fire-proof



Resistant To Stains,  
Chemical Agents

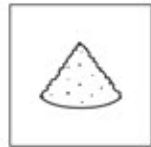

Resistant To Salt

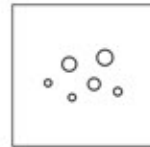

Resistant To Salt

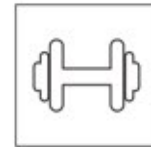

Highly Resistant  
To Heavy Load



High Resistance  
To Thermal Shock

**FUNCTIONAL**



Non-slip Surfaces



Resistant To  
Vehicular Passage  
If Applied To A Screed



ECO-FRIENDLY

**ECO-FRIENDLY**



Eco-friendly



Leed Compliant



**INTENDED USES**

**PORCELAIN STONEWARE TILE 20MM FOR OUTDOOR FLOORING**

Owing to the possibility of installing it dry (on grass, sand, gravel, and elevated floors) the 20mm porcelain outdoor tile collection is the most versatile solution for exterior floors in residential and public areas.

OUTDOOR  
PORCELAIN TILES

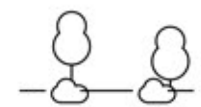

1 DRIVeways AND  
PATHWAYS

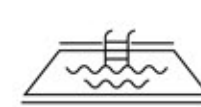

2 SWIMMING POOLS, SPAS  
AND ADJOINING AREAS



3 URBAN FURNITURE  
AND PUBLIC PLACES



4 HIGH-TRAFFIC  
INDUSTRIAL ZONES



5 PUBLIC PARKS  
AND GARDENS



6 TERRACES AND  
BALCONIES



7 CAR PARKS  
AND DRIVEWAY AREAS



OTHER APPLICATION  
SOLUTIONS

OUTDOOR  
PORCELAIN TILES

LAYING SOLUTIONS

Outdoor Porcelain 20mm Tiles Are An Innovative Solution That Is Very Versatile Due To The Numerous Laying Possibilities They Offer: Dry Installation On Grass, Gravel, Or Sand, Screed With Adhesive, And Elevated Floor Installation.

DRY INSTALLATION ON GRASS



A



Easy to lay, adjust, and move. An ideal solution for public parks and private gardens

INSTALLATION ON SCREED WITH ADHESIVE



C



Build resilient and durable outdoor spaces, pathways, driveways, and more with the installation of 20mm tiles on screed with adhesive.

DRY INSTALLATION ON GRAVEL / SAND



B



Easy to lay, adjust, and move. Boasts ideal aesthetic features to enhance contemporary buildings.

ELEVATED FLOOR INSTALLATION

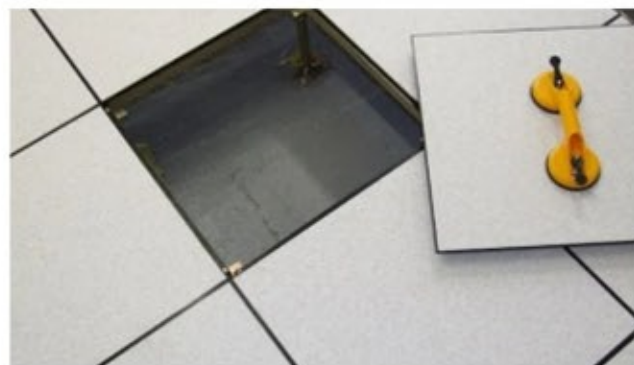

D



Easily removable, inspectible, and reusable. Ideal to be applied with different kinds of support and is apt for concealing wiring pipes, and more with accessibility.

CAUTION

- When carrying out an elevated floor installation it is recommended to check the intended use and to follow the installation instructions.
- It is recommended that the designer/client always check the suitability of the installation system selected according to local regulations in force, and/or

DRY INSTALLATION ON GRASS

To create a pathway with stepping stones, first of all, it is important to determine the number of steps necessary for the entire path, making sure that the tiles are positioned equidistantly. So as to obtain maximum stability, it is recommended to dig out about 5/8cm from the soil, and then place a fine layer of gravel. Compact the substrate and then position the tile. To allow the turf to grow well, it is advisable to leave a gap of at least 10cm between one tile and another.

RESISTANT

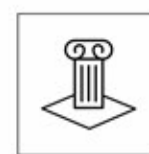

SAFE AND STABLE

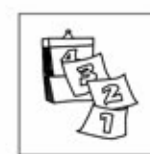

LONG-LASTING



EASY TO CLEAN



DRAINS

It Is Good Practice To Lay The Surface Of The Tiles In Line With The Turf: This Way There Is No Risk Of Damaging The Lawn Mowers

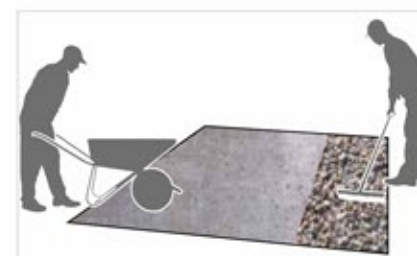
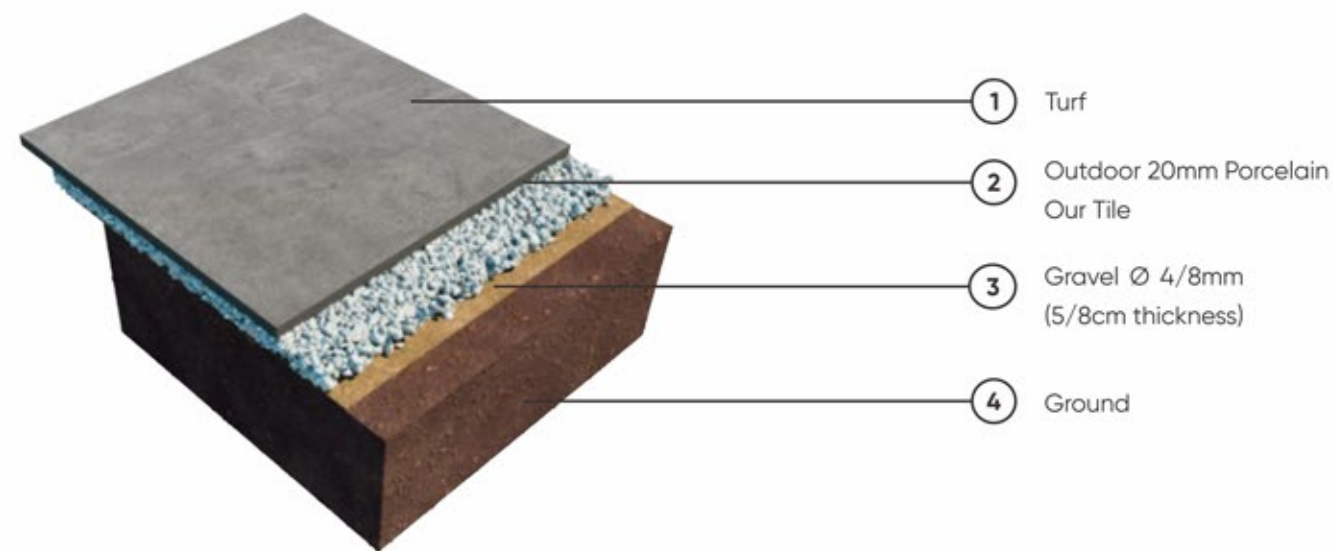

To determine the correct sizing and positioning of the flooring, place the tiles on the ground and carefully position them equidistant from each other. Mark the perimeter of the tile using a spade in the soil.



Remove the turf and dig out about 5cm of soil. Form a stable and uniform substrate using fine gravel (grain size 4/8mm).

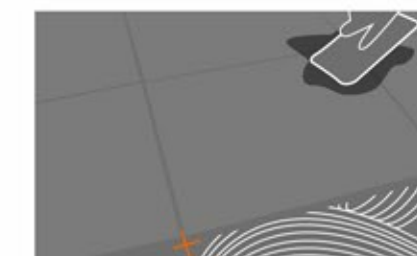

Lay the tile, so as to have an approximately 0.5cm level difference, between the tile and the ground. To simplify tile installation it is possible to use suitable tile installation handles. Knock the tile along the edges with a rubber hammer until it is at the same level as the turf.

CAUTION

The application layers proposed are to be taken as an indication, and have the sole purpose of showing how to obtain a correct flooring.

### DRY INSTALLATION ON GRAVEL / SAND

For installation on sand it is good to remember to place a geotextile on the gravel, on which to spread out a layer (from 2 to 5cm thick) of dry sand with a grain size of 0/2mm. It is necessary to compact the sand with a vibro-compacting plate before proceeding with the installation of the tiles. For particular uses and for stressful loads, it is advisable to consult a technician in order to calculate precisely the thicknesses of the various layers of the substrate.

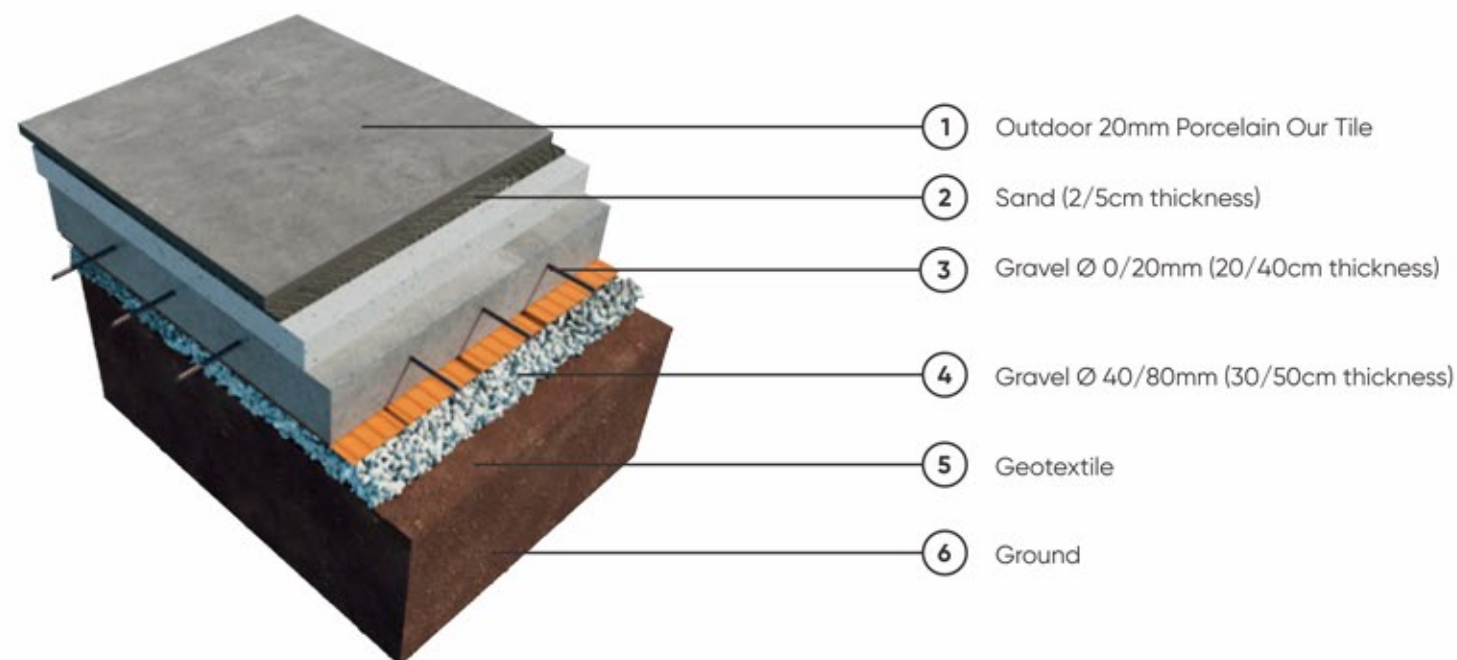
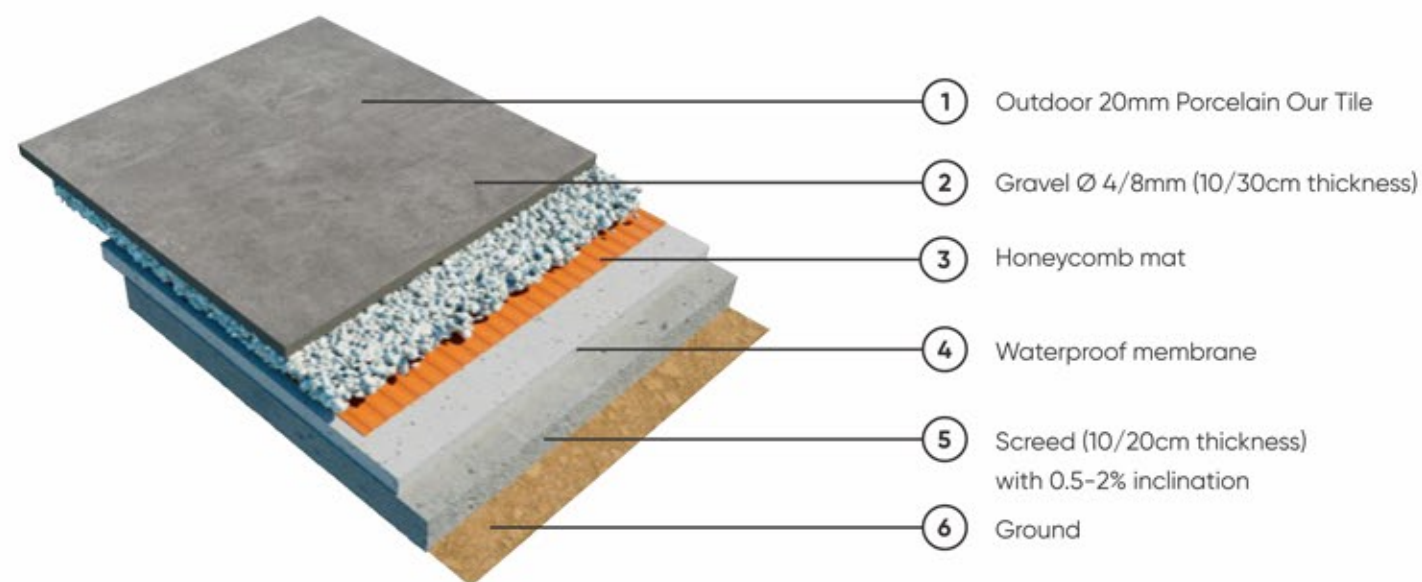

### CAUTION

The application layers proposed are to be taken as an indication, and have the sole purpose of showing how to obtain a correct flooring. It is recommended to always refer to the specific norms and regulations in each individual country and the instructions of the project supervisor

### DRY INSTALLATION ON GRAVEL / SAND

In Order To Avoid The Displacement Of The Substrate And Consequently The Tiles, The Substrate Must Be Partitioned With Containment Edges Or Perimeter Curbs.



Form a stable and uniform substrate using fine gravel or sand. Level the substrate with a metal straight edge.



Position the tile and then compact the edges in order to level the tile with the substrate. It is suggested to use a joint of at least 4mm to allow good water drainage.

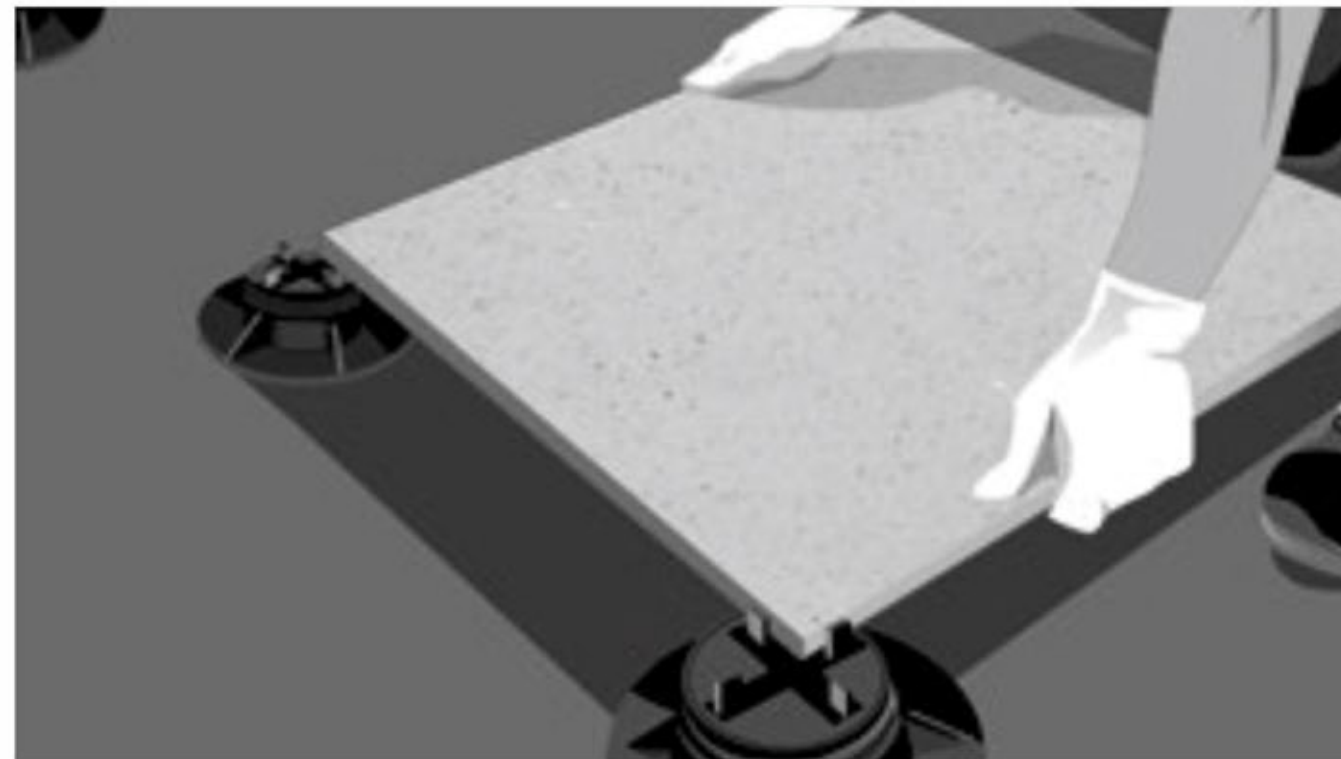

Spacers designed for laying tiles on sand or gravel are an extremely versatile and practical system despite their simplicity. The support is made up of a head with a spacer cross and a removable tip: the fins of the head cross help position the tiles and create the joint between them, ensuring that over time the flooring maintains its correct positioning. The tip is specific for application on sand: the elongated shape guarantees the anchorage and stability of the tiles, preventing them from slipping. For use on gravel, it is possible to remove the tip and place the spacer head directly on the gravel.

## ELEVATED FLOOR INSTALLATION

The elevated floor technology offers many specific and immediately perceivable advantages: it allows the passage of cables, pipes and necessary installations to be managed easily; it enables the underfloor to be inspected easily and guarantees an effective draining of Rainwater. Thanks to the presence of independent elements, elevated floors absorb expansion and structural movements, thus avoiding the formation of cracks on the waterproof embrane. The absence of the screed makes it possible to substantially reduce the weight that burdens the structures, while offering a high resistance to loads.

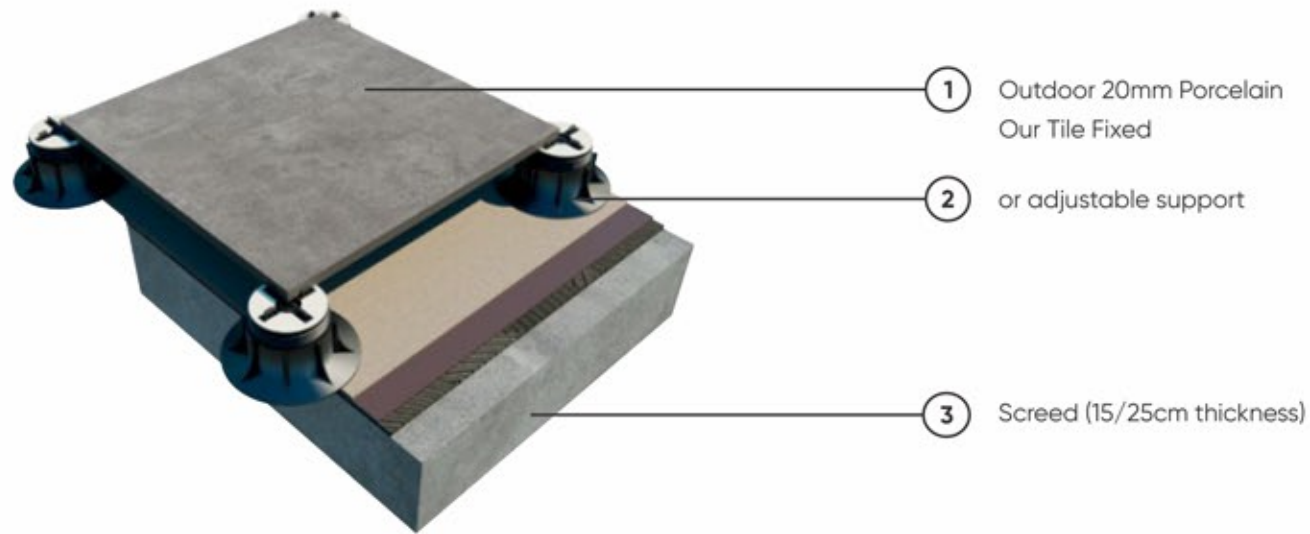

For The Optimal Drainage Of Rainwater, The Elevated Flooring Must Be Installed With A Slope Of Between 1.5% And 2%.



The installation on the plastic supports must only been done on perfectly waterproof substrates. Before proceeding with the installation clean the substrate thoroughly.



With regard to the number and position of the supports, as well as the type of reinforcement on the back of the slab, it is recommended to follow the instructions given in the following table, which are essential to evenly distribute the load.



With the use of the special adjustment key it is possible to obtain a perfectly stable surface and with the required slope for better water drainage.

## CAUTION

The application layers proposed are to be taken as an indication, and have the sole purpose of showing how to obtain a correct flooring. It is recommended to always refer to the specific norms and regulations in each individual country and the instructions of the project supervisor.

## ELEVATED FLOOR INSTALLATION - SUPPORTS

Fixed supports and self-levelling adjustable supports

The structure of the supports consists of a base (which rests on the slab), a central screw adjustable in height and a head (on which the tile rests) which can be fixed or self-levelling with a self-adjustment system to alter inclination by up to 5°.

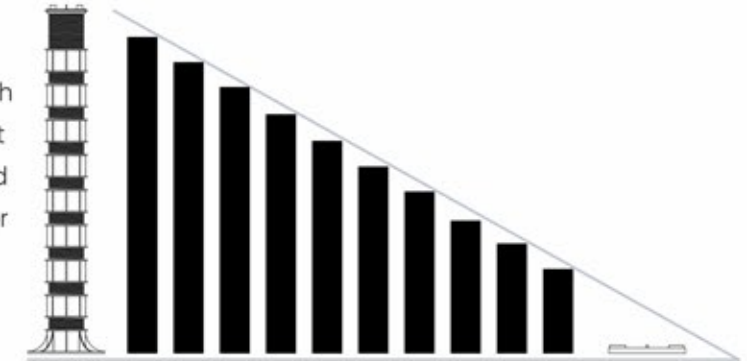

They are made entirely of recycled and recyclable material



Resistant to both acidic and alkaline solutions



Resistant to both acidic and alkaline solutions



Resistant to temperatures of between -30 °C and +120°C



Made of polypropylene

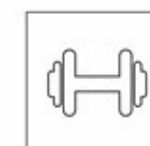

Resistant to the crushing test with a load superior to 1 tonne



Noise reduction of up to 25dB



Possibility of using supports made with self-extinguishing material, which prevents the propagation of flames

Format 60x60cm

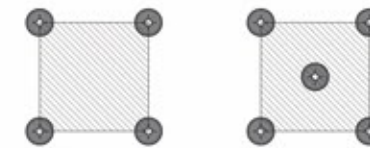

Format 60x90cm

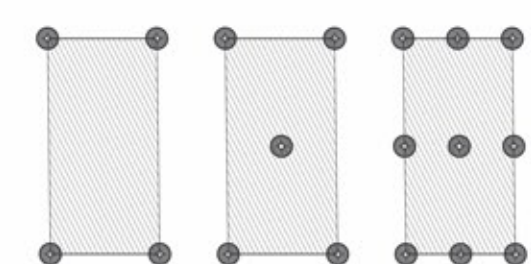

Format 60x90cm

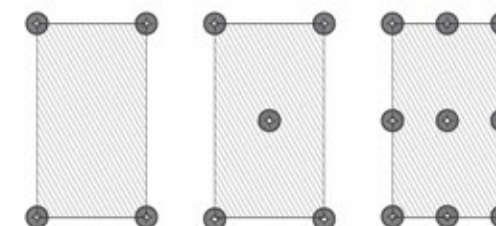

# OUTDOOR PORCELAIN TILES

## SPECIAL ELEMENTS

In order to guarantee excellent aesthetics and functionality for the various possible applications, the 20mm outdoor porcelain Our tile collections have a rich set of step elements and special pieces.

- ① Stair tile with straight edge
- ② Stair tile with rounded edge
- ③ Stair tile with straight ribbed edge
- ④ Stair tile with rounded ribbed edge
- ⑤ Right corner piece with straight edge
- ⑥ Right corner grid
- ⑦ Left corner grid

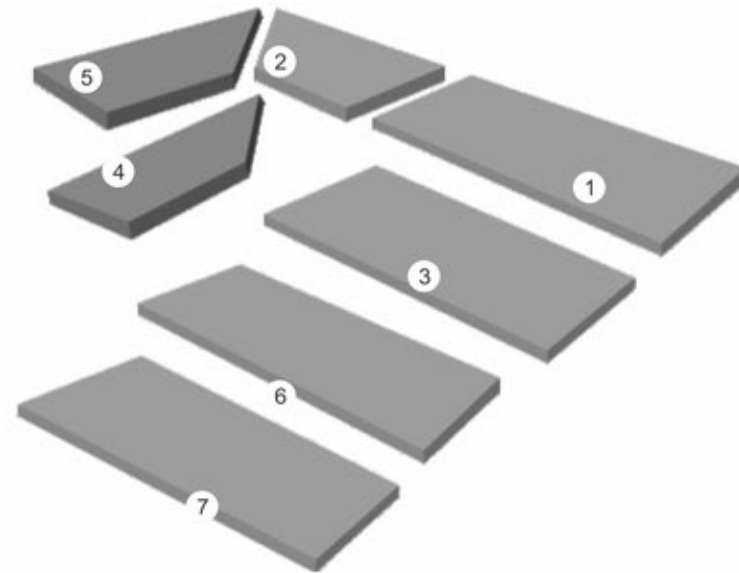

STAIR TILE WITH STRAIGHT EDGE

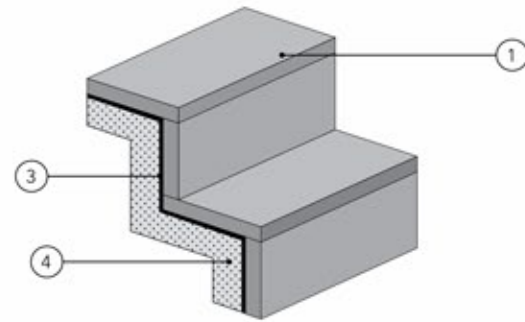

- ① Stair tile with straight edge
- ② Stair tile with rounded edge
- ③ Adhesiv
- ④ Screed
- ⑤ Flooring
- ⑥ Grid
- ⑦ Swimming pool covering

STAIR TILE WITH ROUNDED EDGE

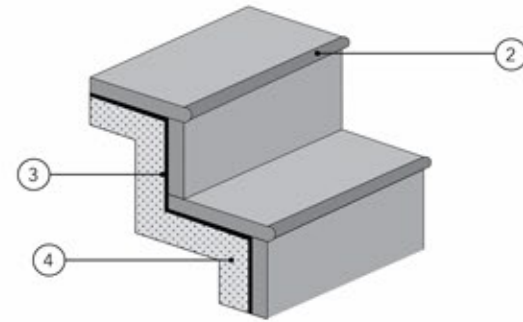

SWIMMING POOL EDGE

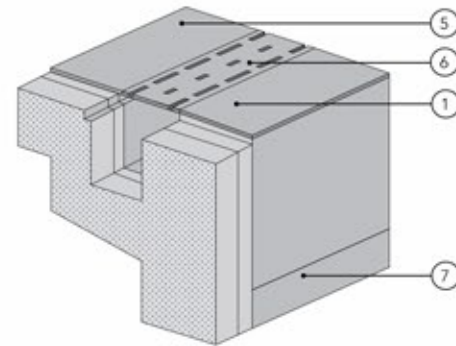

## TECHNICAL DETAILS

TEST DESCRIPTION	ISO-13006/EN176 GROUP BIA	MEAN VALUE OF OUR	TEST METHOD
Length & width	±0.6 %	±0.3mm	Passed
thickness	±5 %	±0.3mm	Passed
Straightness of side	±0.5 %	±0.3 %	Passed
Rectangularity	±0.6 %	±0.3 %	Passed
Surface flatness	±0.5 %	+0.35mm to -0.1mm	Passed
Surface quality	Minimum 95 %	Minimum 95 %	Passed
Water absorption	< 0.5 %	< 0.04 %	Passed
Breaking strength	> 1300N	> 1500N	Passed
Flexural strength (Average)	> 35N/mm <sup>2</sup>	> 40N/mm <sup>2</sup>	Passed
Scratch hardness of surface (Moh's scale)	> 6	> 6	Passed
Resistance to deep abrasion	<175mm <sup>3</sup>	<144mm <sup>3</sup>	Passed
Skid Resistance (Friction coefficient)	>0.4	>0.4	Passed
Bulk Density, in (g/cc)	>2	>2	Passed
Linear Thermal expansion	Max. 9.0 <sup>-6</sup> x K <sup>-6</sup> , Max	Max. 9.0 <sup>-6</sup> x K <sup>-6</sup> , Max	Passed
Thermal shock resistance	No damage	No damage	Passed
Frost resistance	Frost proof	Frost proof	Passed
Resistance to Chemical	Resistance	Resistance	Passed
Resistance to Stain	Resistant	Resistant	Passed
Moisture expansion	Nil	Nil	Passed
Colour resistance	Resistant	Resistant	Passed
Glossiness (Polished)	-	-	Passed

## PACKING DETAILS (OUTDOOR):-

SIZE	BOX WEIGHT	PCS/BOX	SQM/BOX	SQFT/BOX	BOX/PALLET	PALLET/CTN	BOXES/CTN	TOTAL SQM/CTN	CTN WEIGHT (KG)
600x1200mm ( 20mm )	32.5	1	0.72	7.75	30	28	840	604.8	28000
600x900mm ( 20mm )	24.5	1	0.54	5.81	40	28	1120	604.8	28000
600x600 ( 20mm )	32	2	0.72	7.75	36	24	864	622.08	28000
600x1200mm ( 16mm )	25.5	1	0.72	7.75	70 & 34	12 & 7	1078	776.16	28000
600x900mm ( 16mm )	-	-	-	-	-	-	-	-	-
600x600mm ( 16mm )	25.5	2	0.72	7.75	40	27	1080	777.6	28000

## CAUTION

The images are to be taken as an indication, and have the sole purpose of showing how to obtain a correct flooring. It is recommended to always refer to the specific norms and regulations in each individual country and the instructions of the project supervisor.

The information contained in this catalogue is as accurate as possible, but cannot be considered as legally binding. The Company reserves the right to make any modification that becomes necessary due to production requirements. Weight, colors and dimensions are subject to the inevitable variation typical of the ceramic firing process. The colors are possible to the actual colors, within the limits allowed by the printing process. For technical printing reasons, the colors shown may slightly differ from the actual tiles. SUNWORLD VITRIFIED RESERVES THE RIGHT TO MODIFY THE TECHNICAL INFORMATION QUOTED IN THIS CATALOGUE.





Website :  
[www.joneelceramic.com](http://www.joneelceramic.com)

Email :  
[info@joneel.com](mailto:info@joneel.com)

Follow us : 